

# T-LED



## PL

Wąska, nowoczesna oprawa podtynkowa wykonana z blachy stalowej, malowana proszkowo na kolor biały i standardowo wyposażona w zintegrowane źródło światła zasilane w technologii sekwencyjnej. Do wyboru dwa rodzaje klosza: dyfuzyjny lub mikropryzmatyczny. Możliwa jest zmiana kolorystyki ramki dekoracyjnej na wybrany kolor z palety RAL. Dostępna temperatura barwowa 4000 K. Oprawa współpracuje z systemem sterowania DALI.

## EN

Narrow, modern flush-mounted luminaire made of sheet steel, powder-coated in white and comes standard with an integrated light source powered in sequencing technology. Two types of shade to choose from: diffusion or microprism. You can change the color of the decorative frame to the chosen RAL color. Available color temperature 4000 K. The luminaire works with the DALI control system.

## DE

Schmale, moderne Unterputz-Leuchte aus Stahlblech, weiß pulverbeschichtet, standardmäßig mit fest eingebauter Lichtquelle ausgestattet, gespeist in der Technologie mit sequentieller Schaltung. Abdeckungen in zwei Varianten erhältlich: diffus und mikroprismatisch. Die Farbe des Dekorrahmens kann gemäß der RAL-Farbpalette geändert werden. Erhältliche Farbtemperatur 4000 K. Die Leuchte arbeitet mit der DALI-Steuerung.

## OPCJE DO WYBORU / OPTIONS / OPTIONSWAHL MÖGLICH:



D mP  
sD



4000 K  
inna/different/andere\*\*



biały/white/weiß  
kolor/color/Farbe\*\*

D - klosz dyfuzyjny / diffuser cover / diffuse Abdeckung  
sD - klosz super dyfuzyjny / super diffuser cover / Super Diffuse Abdeckung

mP - klosz mikropryzmatyczny / micro-prism cover / mikroprismatische Abdeckung

\*\*Opcje dostępne na zamówienie po konsultacji z działem handlowym. / Options available on request, following consultation with the sales department. / Andere Optionen auf Bestellung nach der Beratung mit der Handelsabteilung erhältlich.

## PL

### PARAMETRY TECHNICZNE

Sposób montażu: podtynkowy  
Obudowa: blacha stalowa  
LED: 3 elipsa MacAdama (SDCM 3)  
Napięcie zasilania: 220-240 V / 50 Hz  
Współczynnik mocy (PF): 0,99  
Poziom zakłóceń harmoniczných THD < 5%  
Klasa ochronności: I  
Wskaźnik oddawania barw CRI(Ra): 85 /90\*\*  
Stopień ochrony: IK07  
Stopień szczelności: IP40, IP65\*\*  
Temperatura otoczenia: od 0°C do +35°C  
Wilgotność otoczenia: 20-80%  
Trwałość (L70B10): 100 000 h  
(L80B10): 50 000 h

**ZASTOSOWANIE:** obiekty handlowe, biura, sale konferencyjne, hotele, restauracje, pomieszczenia mieszkalne, obiekty użyteczności publicznej, korytarze

## EN

### TECHNICAL PARAMETERS

Mounting: flush mounting  
Body: sheet steel  
LED: MacAdam 3 ellipse (SDCM 3)  
Power Supply: 220-240 V / 50 Hz  
Power factor (PF): 0,99  
Harmonic distortion THD < 5%  
Protection class: I  
Color rendering index CRI(Ra): 85 /90\*\*  
Protection marking: IK07  
Protection marking: IP40, IP65\*\*  
Ambient temperature: from 0°C to +35°C  
Ambient humidity: 20-80%  
Lifetime (L70B10): 100 000 h  
(L80B10): 50 000 h

**APPLICATION:** commercial buildings, offices, conference rooms, hotels, restaurants, residential premises, public utility buildings, corridors

## DE

### TECHNISCHE DATEN

Montageart: Unterputz-Montage  
Gehäuse: Stahlblech  
LED: MacAdam 3-Ellipse (SDCM 3)  
Speisespannung: 220-240 V / 50 Hz  
Leistungsfaktor (PF): 0,99  
Harmonische Verzerrung THD < 5%  
Schutzklasse: I  
Farbwiedergabe Faktor CRI(Ra): 85 /90\*\*  
Schutzklasse: IK07  
Schutzklasse: IP40, IP65\*\*  
Umgebungstemperatur: von 0°C bis +35°C  
Umgebungsluftfeuchtigkeit: 20-80%  
Lebensdauer (L70B10): 100 000 h  
(L80B10): 50 000 h

**EINSATZBEREICH:** Handelsobjekte, Büros, Konferenzräume, Hotels, Restaurants, Wohnbereiche, öffentliche Gebäude, Korridore

Deklarowana trwałość dotyczy opraw pracujących w temperaturze otoczenia +25°C przy zapewnionych optymalnych warunkach wentylacji. / The declared lifetime applies to fixtures operating at an ambient temperature of +25°C with ensured optimal ventilation conditions. / Die erklärte Lebensdauer bezieht sich auf Leuchten, die bei einer Raumtemperatur von +25°C und optimalen Lüftungsbedingungen arbeiten.

\* Spełnienie warunku UGR<19 w sensie normy PN-EN 12464-1:2012 jest wymagane dla konkretnego projektu oświetleniowego i zależy od aktualnych warunków oświetleniowych / Compliance with UGR <19 in the sense of PN-EN 12464-1: 2012 is required for a specific lighting project and depends on current lighting conditions / Die Einhaltung von UGR <19 im Sinne von PN-EN 12464-1: 2012 ist für ein bestimmtes Beleuchtungsprojekt erforderlich und hängt von den aktuellen Lichtverhältnissen ab



EAN	CODE	[W]	[K]		[°]	[lm]	[lm/W]	
<b>Typ: 600, DALI, IP40 / Type: 600, DALI, IP40 / Art: 600, DALI, IP40</b>								
5902194053754	027906D840-0D01-0001	20	4000	D	108	1900	95	DALI
5902194053761	027906D840-mP01-0001	20	4000	mP	86	2000	100	DALI
5902194076241	027906D840-sD01-0001	20	4000	sD	90	2000	100	DALI
5902194053730	027906D840-0D01-0002	25	4000	D	108	2200	88	DALI
5902194053747	027906D840-mP01-0002	25	4000	mP	86	2400	96	DALI
5902194076258	027906D840-sD01-0002	25	4000	sD	90	2500	100	DALI
<b>Typ: 1100, DALI, IP40 / Type: 1100, DALI, IP40 / Art: 1100, DALI, IP40</b>								
5902194053716	027910D840-0D01-0002	25	4000	D	108	2200	88	DALI
5902194053723	027910D840-mP01-0002	25	4000	mP	86	2400	96	DALI
5902194076265	027910D840-sD01-0002	25	4000	sD	90	2500	100	DALI
5902194053693	027910D840-0D01-0004	35	4000	D	108	3400	97	DALI
5902194053709	027910D840-mP01-0004	35	4000	mP	86	3500	100	DALI
5902194076272	027910D840-sD01-0004	35	4000	sD	90	3700	106	DALI
5902194053679	027910D840-0D01-0006	45	4000	D	108	4100	91	DALI
5902194053686	027910D840-mP01-0006	45	4000	mP	86	4400	98	DALI
5902194076289	027910D840-sD01-0006	45	4000	sD	90	4500	100	DALI
<b>Typ: 1580, DALI, IP40 / Type: 1580, DALI, IP40 / Art: 1580, DALI, IP40</b>								
5902194053655	027916D840-0D01-0008	55	4000	D	108	4800	87	DALI
5902194053662	027916D840-mP01-0008	55	4000	mP	86	5000	91	DALI
5902194076296	027916D840-sD01-0008	55	4000	sD	90	5000	91	DALI
5902194053631	027916D840-0D01-0011	70	4000	D	108	6400	91	DALI
5902194053648	027916D840-mP01-0011	70	4000	mP	86	6700	96	DALI
5902194076302	027916D840-sD01-0011	70	4000	sD	90	7000	100	DALI
<b>Typ: 2070, DALI, IP40 / Type: 2070, DALI, IP40 / Art: 2070, DALI, IP40</b>								
5902194053617	027921D840-0D01-0007	50	4000	D	108	5000	100	DALI
5902194053624	027921D840-mP01-0007	50	4000	mP	86	5300	106	DALI
5902194076319	027921D840-sD01-0007	50	4000	sD	90	5200	104	DALI
5902194053594	027921D840-0D01-0011	70	4000	D	108	6700	96	DALI
5902194053600	027921D840-mP01-0011	70	4000	mP	86	7100	101	DALI
5902194076326	027921D840-sD01-0011	70	4000	sD	90	7300	104	DALI
5902194053570	027921D840-0D01-0013	90	4000	D	108	8300	92	DALI
5902194053587	027921D840-mP01-0013	90	4000	mP	86	8600	96	DALI
5902194075817	027921D840-sD01-0013	90	4000	sD	90	8900	99	DALI
<b>Typ: 2560, DALI, IP40 / Type: 2560, DALI, IP40 / Art: 2560, DALI, IP40</b>								
5902194075824	027926D840-0D01-0008	55	4000	D	108	5100	93	DALI
5902194075831	027926D840-mP01-0008	55	4000	mP	86	5300	96	DALI
5902194075848	027926D840-sD01-0008	55	4000	sD	90	5500	100	DALI
5902194075855	027926D840-0D01-0011	70	4000	D	108	6100	87	DALI
5902194075862	027926D840-mP01-0011	70	4000	mP	86	6300	90	DALI
5902194075879	027926D840-sD01-0011	70	4000	sD	90	6500	93	DALI

Całkowity strumień świetlny oprawy zmierzony za kloszem przy temp. otoczenia +25°C. Tolerancja strumienia świetlnego +/- 10%. Pomiary fotometryczne zostały wykonane zgodnie z wymaganiami normy PN-EN13032. / The total luminous flux of the luminaire measured diffuser +25°C. Luminous flux tolerance +/- 10%. Photometric measurement were examined in accordance with the PN-EN13032 system. / Gesamtlichtstrom der Leuchte, gemessen hinter der Abdeckung +25°C. Lichtstrom-Toleranz +/- 10%. Photometrische Messungen wurden nach PN-EN13032 Norm geprüft.

FOTOMETRIA / PHOTOMETRY / PHOTOMETRIE:

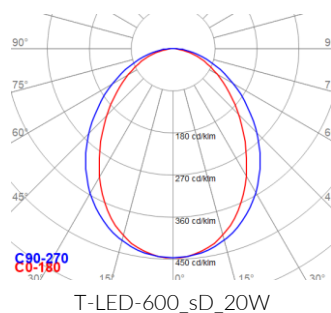
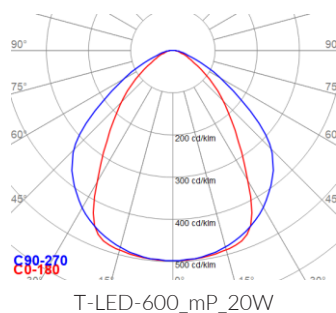
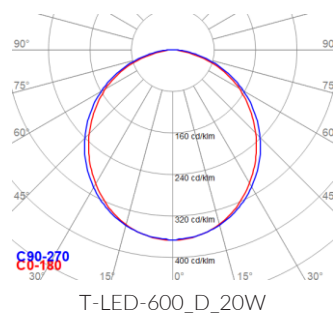

WYMIARY / DIMENSIONS / MASSE:



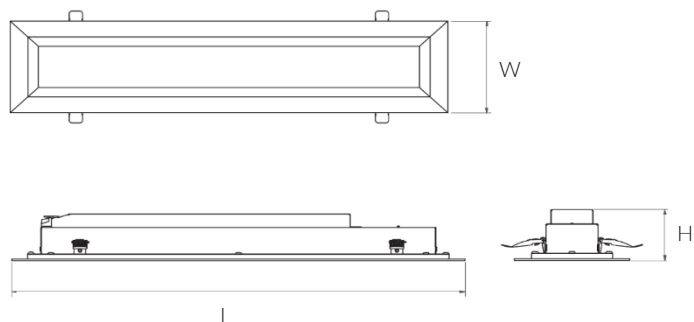



















NAME	L [mm]	W [mm]	H [mm]	[kg]	[mm]
T-LED 600	605	142	70	1,2	570 x 108
T-LED 1100	1093	142	70	2,0	1060 x 108
T-LED 1580	1581	142	70	3,0	1545 x 108
T-LED 2070	2069	142	70	3,8	2035 x 108



W związku z ciągłym rozwojem produktów zastrzegamy sobie prawo do wprowadzania zmian konstrukcyjnych w oprawach oraz aktualizowania parametrów.  
 Due to continuous product development, we reserve the right to introduce structural changes in the fixtures and to update their parameters.  
 Aufgrund der ständigen Produktentwicklung behalten wir uns das Recht vor, technische Änderungen und Aktualisierung von Parametern an Leuchten vorzunehmen.

Data aktualizacji / Revision Date / Datum der letzten Aktualisierung: 13.08.2020

LEGENDA / LEGEND / LEGENDE:

	Deklaracja zgodności Declaration of conformity EG-Konformitätserklärung		Klasa ochronności I Protection class I Schutzklasse I		Napięcie zasilania Power supply Speisespannung
	Źródło światła LED LED source LED Quelle		Klasa efektywności energetycznej Energy efficiency class Energieeffizienzklasse		Dyrektywa RoHS The RoHS Directive RoHS Richtlinie
	Wymiary montażowe Mounting dimensions Montagemaße		Stopień szczelności IP IP protection marking Schutzklasse IP		Atest higieniczny PZH Hygiene certificate of the NIH Attest von Polnischer Hygieneanstalt
	Kod produktu Code Artikelnummer		Rodzaj klosza Cover Abdeckung		Moc oprawy Luminaire power Leistung der Leuchte
	Kąt rozsyłu światłości Light distribution angle Winkel der Lichtverteilung		Wymiary Dimensions Masse		Temperatura barwowa Color temperature Farbtemperatur
	Strumień świetlny Luminous flux Lichtstrom		Skuteczność świetlna Luminous efficiency Lichtausbeute der Leuchte		System sterowania DALI DALI control system Steuersystem DALI
	Kolor oprawy Luminaire color Leuchte Farbe		Waga Weight Gewicht		Nazwa produktu Product name Produktname
	Wskaźnik ośnienia przykrego Glare indicator Blendungsanzeige				