

I-SPOT SPECIAL

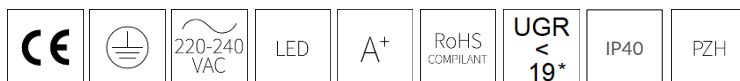

PL

Oprawa I-SPOT SPECIAL jest kierunkową oprawą LED montowaną na szynoprzewodzie przeznaczoną do oświetlania żywności. Do wyboru modele zaprojektowane do oświetlania mięsa, pieczywa, ryb, serów, warzyw i owoców, alkoholi lub ubrań. Każdy model dostępny w czterech wariantach optyki (20°, 30°, 40°, 50°). Oprawa dostępna w kolorach białym i czarnym lub innym na zamówienie.

EN

I-SPOT SPECIAL directional LED lighting fitting is mounted on the busway designed for lighting of food. A choice of models designed to illuminate meat, bread, fish, cheese, vegetables and fruit, alcohol or clothes. Each model is available in four different optics (20°, 30°, 40°, 50°). The lighting fitting is available in white and black or others colours on request.

DE

Die Leuchte I-SPOT SPECIAL ist eine LED-Punktlichtquelle, die an einer Schiene zur Beleuchtung von Lebensmitteln montiert wird. Zur Wahl stehen den Kunden Leuchten für Fleischwaren, Backwaren, Fisch, Käse, Gemüse, Obst und Alkohol oder Kleidung. Jedes Modell ist in vier Optik Varianten erhältlich (20°, 30°, 40°, 50°). Die Leuchte kann in Weiß, Schwarz oder in einer anderen Farbe auf Bestellung ausgeführt werden.

OPCJE DO WYBORU / OPTIONS / OPTIONSWAHL MÖGLICH:



MEAT** BREAD** FISH** CHEESE**
VEG-FRU** ALCO-W** ALCO-C** CLOTHES**



20° 40°
30° 50°



biały/white/weiß
czarny/black/schwarz
inny/different/andere**

**Opcje dostępne na zamówienie po konsultacji z działem handlowym. / Options available on request, following consultation with the sales department. / Andere Optionen auf Bestellung nach der Beratung mit der Handelsabteilung erhältlich.

PL

PARAMETRY TECHNICZNE

Sposób montażu: na szynoprzewodzie, natynkowy**
Obudowa: ABS i aluminium
LED: 3 elipsa MacAdama (SDCM 3)
Napięcie zasilania: 220-240 V / 50 Hz
Współczynnik mocy (PF): 0,99
Poziom zakłóceń harmoniczných THD < 5%
Klasa ochronności: I
Stopień ochrony: IK07
Stopień szczelności: IP40
Temperatura otoczenia: od 0°C do +35°C
Wilgotność otoczenia: 20-80%
Trwałość (L70B10): 50 000 h

ZASTOSOWANIE: obiekt handlowe

EN

TECHNICAL PARAMETERS

Mounting: on track, surface mounting**
Body: ABS and aluminium
LED: MacAdam 3 ellipse (SDCM 3)
Power Supply: 220-240 V / 50 Hz
Power factor (PF): 0,99
Harmonic distortion THD < 5%
Protection class: I
Protection marking: IK07
Protection marking: IP40
Ambient temperature: from 0°C to +35°C
Ambient humidity: 20-80%
Lifetime (L70B10): 50 000 h

APPLICATION: commercial buildings

DE

TECHNISCHE DATEN

Montageart: für raupen ausgelegt, zur Aufputz-Montage**
Gehäuse: ABS und Aluminium
LED: MacAdam 3-Ellipse (SDCM 3)
Speisespannung: 220-240 V / 50 Hz
Leistungsfaktor (PF): 0,99
Harmonische Verzerrung THD < 5%
Schutzklasse: I
Schutzklasse: IK07
Schutzklasse: IP40
Umgebungstemperatur: von 0°C bis +35°C
Umgebungsfeuchtigkeit: 20-80%
Lebensdauer (L70B10): 50 000 h

EINSATZBEREICH: Handelsobjekte

Deklarowana trwałość dotyczy opraw pracujących w temperaturze otoczenia +25°C przy zapewnionych optymalnych warunkach wentylacji. / The declared lifetime applies to fixtures operating at an ambient temperature of +25°C with ensured optimal ventilation conditions. / Die erklärte Lebensdauer bezieht sich auf Leuchten, die bei einer Raumtemperatur von +25°C und optimalen Lüftungsbedingungen arbeiten.

* Spełnienie warunku UGR<19 w sensie normy PN-EN 12464-1:2012 jest wymagane dla konkretnego projektu oświetleniowego i zależy od aktualnych warunków oświetleniowych / Compliance with UGR <19 in the sense of PN-EN 12464-1: 2012 is required for a specific lighting project and depends on current lighting conditions / Die Einhaltung von UGR <19 im Sinne von PN-EN 12464-1: 2012 ist für ein bestimmtes Beleuchtungsprojekt erforderlich und hängt von den aktuellen Lichtverhältnissen ab



EAN

CODE

[W]

[K]

[°]

[lm]

[lm/W]

Typ: DALI, biała / Type: DALI, white / Art: DALI, weiß

Typ: Mięso / Type: Meat / Art: Fleisch

5902194037631	049400DMEA-DS00-0008	35	MEAT	DS	20	2000	57	DALI
5902194037648	049400DMEA-DS00-0108	35	MEAT	DS	30	2000	57	DALI
5902194037655	049400DMEA-DS00-0208	35	MEAT	DS	40	2000	57	DALI
5902194037662	049400DMEA-DS00-0308	35	MEAT	DS	50	2000	57	DALI

Typ: Pieczywo / Type: Bread / Art: Backware

5902194037310	049400DBRE-DS00-0008	35	BREAD	DS	20	2900	83	DALI
5902194037327	049400DBRE-DS00-0108	35	BREAD	DS	30	2900	83	DALI
5902194037334	049400DBRE-DS00-0208	35	BREAD	DS	40	2900	83	DALI
5902194037341	049400DBRE-DS00-0308	35	BREAD	DS	50	2900	83	DALI

Typ: Ryby / Type: Fish / Art: Fische

5902194037556	049400DFIS-DS00-0008	35	FISH	DS	20	3200	91	DALI
5902194037563	049400DFIS-DS00-0108	35	FISH	DS	30	3200	91	DALI
5902194037570	049400DFIS-DS00-0208	35	FISH	DS	40	3200	91	DALI
5902194037587	049400DFIS-DS00-0308	35	FISH	DS	50	3200	91	DALI

Typ: Sery / Type: Cheese / Art: Käse

5902194037396	049400DCHE-DS00-0008	35	CHEESE	DS	20	3000	86	DALI
5902194037402	049400DCHE-DS00-0108	35	CHEESE	DS	30	3000	86	DALI
5902194037419	049400DCHE-DS00-0208	35	CHEESE	DS	40	3000	86	DALI
5902194037426	049400DCHE-DS00-0308	35	CHEESE	DS	50	3000	86	DALI

Typ: Warzywa i owoce / Type: Vegetables and fruits / Art: Gemüse und Obst

5902194037716	049400DVEF-DS00-0008	35	VEG-FRU	DS	20	3000	86	DALI
5902194037723	049400DVEF-DS00-0108	35	VEG-FRU	DS	30	3000	86	DALI
5902194037730	049400DVEF-DS00-0208	35	VEG-FRU	DS	40	3000	86	DALI
5902194037747	049400DVEF-DS00-0308	35	VEG-FRU	DS	50	3000	86	DALI

Typ: Alkohol-biały / Type: Alcohol-white / Art: Alkohol-weiß

5902194037235	049400DALW-DS00-0008	35	ALCO-W	DS	20	3200	91	DALI
5902194037242	049400DALW-DS00-0108	35	ALCO-W	DS	30	3200	91	DALI
5902194037259	049400DALW-DS00-0208	35	ALCO-W	DS	40	3200	91	DALI
5902194037266	049400DALW-DS00-0308	35	ALCO-W	DS	50	3200	91	DALI

Typ: Alkohol-kolorowy / Type: Alcohol-colour / Art: Alkohol-farbig

5902194037150	049400DALC-DS00-0008	35	ALCO-C	DS	20	3000	86	DALI
5902194037167	049400DALC-DS00-0108	35	ALCO-C	DS	30	3000	86	DALI
5902194037174	049400DALC-DS00-0208	35	ALCO-C	DS	40	3000	86	DALI
5902194037181	049400DALC-DS00-0308	35	ALCO-C	DS	50	3000	86	DALI

Typ: Ubrania / Type: clothes / Art: Kleidung

5902194037471	049400DCLO-DS00-0008	35	CLOTHES	DS	20	3000	86	DALI
5902194037488	049400DCLO-DS00-0108	35	CLOTHES	DS	30	3000	86	DALI
5902194037495	049400DCLO-DS00-0208	35	CLOTHES	DS	40	3000	86	DALI
5902194037501	049400DCLO-DS00-0308	35	CLOTHES	DS	50	3000	86	DALI

Typ: DALI, czarna / Type: DALI, black / Art: DALI, schwarz

Typ: Mięso / Type: Meat / Art: Fleisch

5902194037679	049400DMEA-DS11-0008	35	MEAT	DS	20	2000	57	DALI
5902194037686	049400DMEA-DS11-0108	35	MEAT	DS	30	2000	57	DALI
5902194037693	049400DMEA-DS11-0208	35	MEAT	DS	40	2000	57	DALI
5902194037709	049400DMEA-DS11-0308	35	MEAT	DS	50	2000	57	DALI

Typ: Pieczywo / Type: Bread / Art: Backware

5902194037358	049400DBRE-DS11-0008	35	BREAD	DS	20	2900	83	DALI
5902194037365	049400DBRE-DS11-0108	35	BREAD	DS	30	2900	83	DALI
5902194037372	049400DBRE-DS11-0208	35	BREAD	DS	40	2900	83	DALI
5902194037389	049400DBRE-DS11-0308	35	BREAD	DS	50	2900	83	DALI

Typ: Ryby / Type: Fish / Art: Fische

5902194037594	049400DFIS-DS11-0008	35	FISH	DS	20	3200	91	DALI
5902194037600	049400DFIS-DS11-0108	35	FISH	DS	30	3200	91	DALI
5902194037617	049400DFIS-DS11-0208	35	FISH	DS	40	3200	91	DALI
5902194037624	049400DFIS-DS11-0308	35	FISH	DS	50	3200	91	DALI

Typ: Sery / Type: Cheese / Art: Käse

5902194037433	049400DCHE-DS11-0008	35	CHEESE	DS	20	3000	86	DALI
5902194037440	049400DCHE-DS11-0108	35	CHEESE	DS	30	3000	86	DALI
5902194037457	049400DCHE-DS11-0208	35	CHEESE	DS	40	3000	86	DALI
5902194037464	049400DCHE-DS11-0308	35	CHEESE	DS	50	3000	86	DALI

Typ: Warzywa i owoce / Type: Vegetables and fruits / Art: Gemüse und Obst

5902194037754	049400DVEF-DS11-0008	35	VEG-FRU	DS	20	3000	86	DALI
5902194037761	049400DVEF-DS11-0108	35	VEG-FRU	DS	30	3000	86	DALI
5902194037778	049400DVEF-DS11-0208	35	VEG-FRU	DS	40	3000	86	DALI
5902194037785	049400DVEF-DS11-0308	35	VEG-FRU	DS	50	3000	86	DALI

Typ: Alkohol-biały / Type: Alcohol-white / Art: Alkohol-weiß

5902194037273	049400DALW-DS11-0008	35	ALCO-W	DS	20	3200	91	DALI
5902194037280	049400DALW-DS11-0108	35	ALCO-W	DS	30	3200	91	DALI
5902194037297	049400DALW-DS11-0208	35	ALCO-W	DS	40	3200	91	DALI
5902194037303	049400DALW-DS11-0308	35	ALCO-W	DS	50	3200	91	DALI

Typ: Alkohol-kolorowy / Type: Alcohol-colour / Art: Alkohol-farbig

5902194037198	049400DALC-DS11-0008	35	ALCO-C	DS	20	3000	86	DALI
5902194037204	049400DALC-DS11-0108	35	ALCO-C	DS	30	3000	86	DALI
5902194037211	049400DALC-DS11-0208	35	ALCO-C	DS	40	3000	86	DALI
5902194037228	049400DALC-DS11-0308	35	ALCO-C	DS	50	3000	86	DALI

Typ: Ubrania / Type: clothes / Art: Kleidung

5902194037518	049400DCLO-DS11-0008	35	CLOTHES	DS	20	3000	86	DALI
5902194037525	049400DCLO-DS11-0108	35	CLOTHES	DS	30	3000	86	DALI
5902194037532	049400DCLO-DS11-0208	35	CLOTHES	DS	40	3000	86	DALI
5902194037549	049400DCLO-DS11-0308	35	CLOTHES	DS	50	3000	86	DALI

Całkowity strumień świetlny oprawy zmierzony za kloszem przy temp. otoczenia +25°C. Tolerancja strumienia świetlnego +/- 10%. Pomiar fotometryczny został wykonany zgodnie z wymaganiami normy PN-EN13032. / The total luminous flux of the luminaire measured diffuser +25°C. Luminous flux tolerance +/- 10%. Photometric measurement were examined in accordance with the PN-EN13032 system. / Gesamtlichtstrom der Leuchte, gemessen hinter der Abdeckung +25°C. Lichtstrom-Toleranz +/- 10%. Photometrische Messungen wurden nach PN-EN13032 Norm geprüft.

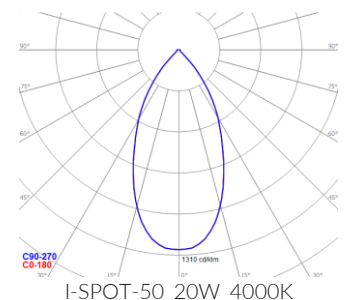
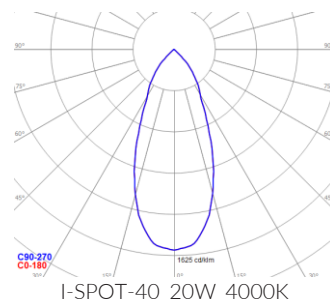
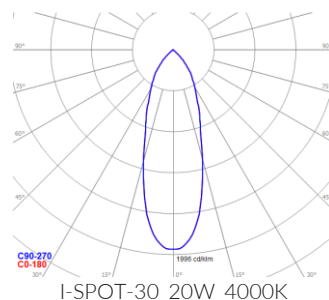
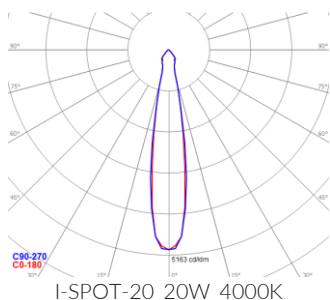
FOTOMETRIA / PHOTOMETRY / PHOTOMETRIE:

WYMIARY / DIMENSIONS / MASSE:

NAME





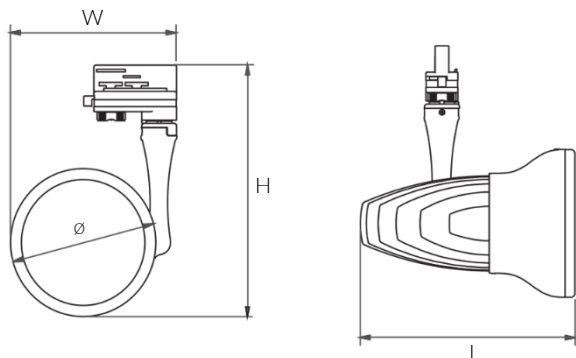



















	L [mm]	W [mm]	H [mm]	∅ [mm]	[kg]
I-SPOT	216	166	248	146	1,0



W związku z ciągłym rozwojem produktów zastrzegamy sobie prawo do wprowadzania zmian konstrukcyjnych w oprawach oraz aktualizowania parametrów.
 Due to continuous product development, we reserve the right to introduce structural changes in the fixtures and to update their parameters.
 Aufgrund der ständigen Produktentwicklung behalten wir uns das Recht vor, technische Änderungen und Aktualisierung von Parametern an Leuchten vorzunehmen.

Data aktualizacji / Revision Date / Datum der letzten Aktualisierung: 13.08.2020

LEGENDA / LEGEND / LEGENDE:

	Deklaracja zgodności Declaration of conformity EG-Konformitätserklärung		Klasa ochronności I Protection class I Schutzklasse I		Napięcie zasilania Power supply Speisespannung
	Źródło światła LED LED source LED Quelle		Klasa efektywności energetycznej Energy efficiency class Energieeffizienzklasse		Dyrektywa RoHS The RoHS Directive RoHS Richtlinie
	Wymiary montażowe Mounting dimensions Montagemaße		Stopień szczelności IP IP protection marking Schutzklasse IP		Atest higieniczny PZH Hygiene certificate of the NIH Attest von Polnischer Hygieneanstalt
	Kod produktu Code Artikelnummer		Rodzaj klosza Cover Abdeckung		Moc oprawy Luminaire power Leistung der Leuchte
	Kąt rozsyłu światłości Light distribution angle Winkel der Lichtverteilung		Wymiary Dimensions Masse		Temperatura barwowa Color temperature Farbtemperatur
	Strumień świetlny Luminous flux Lichtstrom		Skuteczność świetlna Luminous efficiency Lichtausbeute der Leuchte		System sterowania DALI DALI control system Steuersystem DALI
	Kolor oprawy Luminaire color Leuchte Farbe		Waga Weight Gewicht		Nazwa produktu Product name Produktname
	Wskaźnik ośnienia przykrego Glare indicator Blendungsanzeige				